

ProChipper®

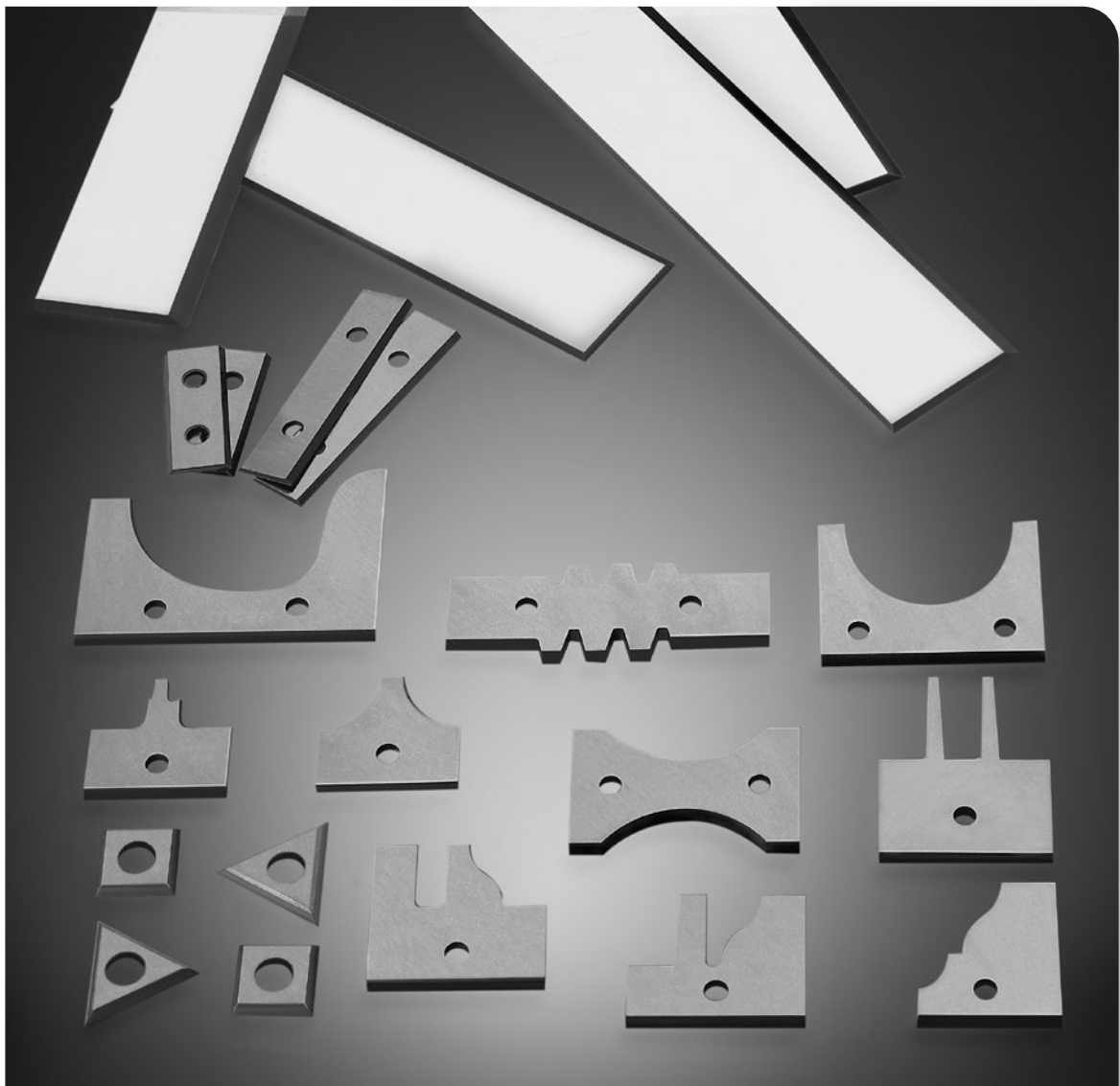

tooling systems



Messer, Ersatzteile und Hilfsmittel
Knives, Spare Parts and Tooling Accessories

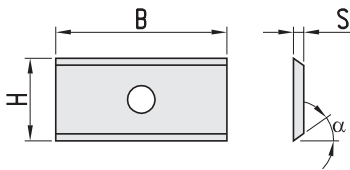

- HF21:** Für Weichholz
for softwood
- HF10:** Standardqualität
for standard quality wood
- HF01:** Für MDF und abrasive Werkstoffe
for MDF and abrasive materials
- FMG02:** Für MDF und HDF
for MDF and HDF
- KCR08:** Für erhöhte Standzeiten
for longer tool life

Auf Anfrage erhältlich
available on request

Ausführung 1 mit 2 Schneidkanten und 1 Loch
Type 1 with two cutting edges and one hole
HW

B	H	S	α	Körnung - Grain	Art. Nr.
$\alpha = 35^\circ$					
7,5	12	1,5	35°	HF10	750.097
	12	1,5	45°	HF21	752.501
8,6	12	1,5	35°	HF10	750.095
9,0	12	1,5	35°	HF10	750.096
9,6	12	1,5	35°	HF10	750.098
	12	1,5	45°	HF21	752.502
10,5	12	1,5	35°	HF10	750.200
11,0	12	1,5	35°	HF10	750.209
11,6	12	1,5	35°	HF10	750.099
	12	1,5	45°	HF21	750.503
13,0	12	1,5	35°	HF10	750.202
14,6	12	1,5	35°	HF10	750.201
15,0	12	1,5	35°	HF10	750.101
	12	1,5	45°	HF21	750.504
15,7	12	1,5	35°	HF10	750.203
16,0	12	1,5	35°	HF10	750.206
17,0	12	1,5	35°	HF10	750.115
17,6	12	1,5	35°	HF10	750.205
19,6	12	1,5	35°	HF10	750.208
20,0	12	1,5	35°	HF10	750.102
	12	1,5	35°	HF01	751.104
	12	1,5	35°	FMG02	752.101
	12	1,5	45°	HF21	752.505
21,6	12	1,5	35°	HF10	750.204
24,7	12	1,5	35°	HF10	750.103
$\alpha = 45^\circ$					
7,5	12	1,5	45°	HF21	752.501
9,6	12	1,5	45°	HF21	752.502
11,6	12	1,5	45°	HF21	752.503
15,0	12	1,5	45°	HF21	752.504
20,0	12	1,5	45°	HF21	752.505

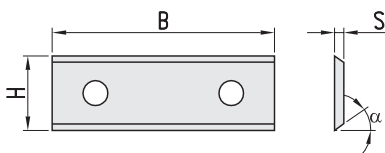
Ausführung 2 mit 2 Schneidkanten und 2 Löchern
Type 2 with two cutting edges and two holes
HW

B	H	S	α	Körnung - w	Art. Nr.
$\alpha = 35^\circ$					
30	12	1,5	35°	HF10	750.104
30	12	1,5	35°	HF01	751.105
30	12	1,5	35°	FMG02	752.102
40	12	1,5	35°	HF10	750.105
50	12	1,5	35°	HF10	750.106
50	12	1,5	35°	HF01	751.107
50	12	1,5	35°	FMG02	752.103
60	12	1,5	35°	HF10	750.107
80	12	2,2	35°	HF10	750.108
100	12	2,2	35°	HF10	750.109
120	12	2,2	35°	HF10	750.110
$\alpha = 45^\circ$					
30	12	1,5	45°	HF21	752.507
40	12	1,5	45°	HF21	752.508
50	12	1,5	45°	HF21	752.509
60	12	1,5	45°	HF21	752.510
80	12	2,2	45°	HF21	752.511

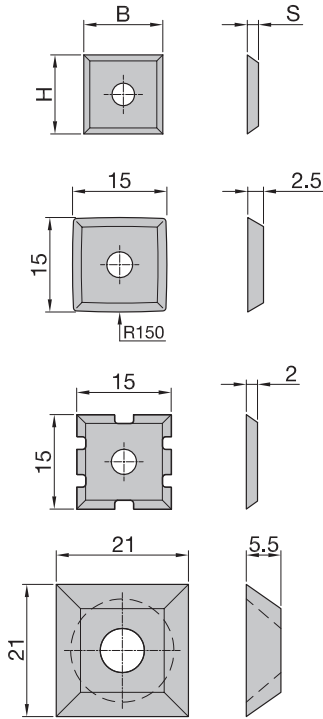

Ausführung 1 - Type 1

Ausführung 1 mit 4 Schneidkanten und 1 Senkloch
Type 1 with four cutting edges and one screw hole

HW

B	H	S	Körnung - Grain	Art. Nr.
12,0	12,0	1,5	HF10	754.102
	12,0	1,5	FMG02	752.100
14,0	14,0	2,0	HF10	750.111
	14,0	1,7		750.112
	14,0	1,2		750.113
14,3	14,3	2,5		750.116
15,0	15,0	2,0	SPB - Chipbreaker	754.301
	15,0	2,5	ballig - crowned	754.106
17,0	17,0	2,0	HF10	754.104
19,0	19,0	2,0	HF10	754.105
21,0	21,0	5,5		754.302

- HF21:** Für Weichholz
for softwood
- HF10:** Standardqualität
for standard quality wood
- HF01:** Für MDF und abrasive Werkstoffe
for MDF and abrasive materials
- FMG02:** Für MDF und HDF
for MDF and HDF
- KCR08:** Für erhöhte Standzeiten
for longer tool life

Auf Anfrage erhältlich
available on request

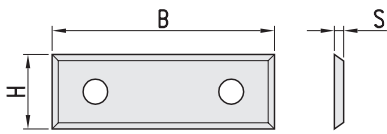

Ausführung 2 - Type 2

Ausführung 2 mit 4 Schneidkanten und 2 Löchern
Type 2 with four cutting edges and two holes

HW

B	H	S	Körnung - Grain	Art. Nr.
29,5	9	1,5	HF10	753.204
	12	1,5	HF10	753.207
49,5	9	1,5		753.204
	12	1,5	HF10	753.307
50,0	12	1,7	HF10	753.350

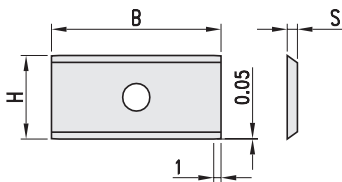

Für Aufbausystem
For assembly system

HW

B	H	S	Art. Nr.
20,0	12	1,5	755.101
24,7	12	1,5	755.102
30,0	12	1,5	755.103
50,0	12	1,5	755.105



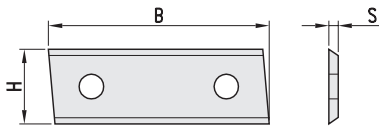

Ausführung 1 - Type 1

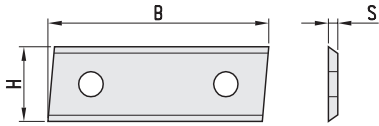

Ausführung 2 - Type 2

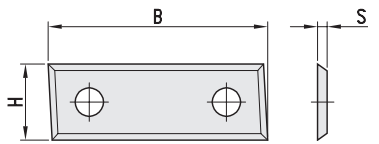
Ausführung mit 2 Schneidkanten
Type with two cutting edges

HW

B	H	S	Art. Nr.
Ausführung 1 - Type 1			
20	12	1,5	757.101
30	12	1,5	757.102
50	12	1,5	757.103
Ausführung 2 - Type 2			
20	12	1,5	757.201
30	12	1,5	757.202
50	12	1,5	757.203

Ausführung mit 4 Schneidkanten
Type with four cutting edges

HW

B	H	S	Art. Nr.
29,5	9	1,5	757.500
	12	1,5	757.150
49,5	9	1,5	757.501
	12	1,5	757.151

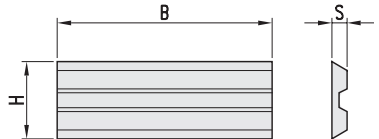

Ausführung 1 - Type 1

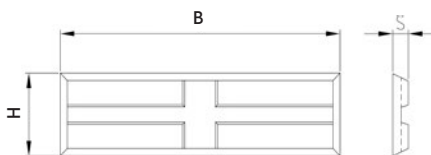

Ausführung 2 - Type 2



Ausführung 3 - Type 3

Ausführung 1
Type 1

HW

B	H	S	Art. Nr.
12	5,5	1,1	758.101
20	5,5	1,1	758.102
30	5,5	1,1	758.103
40	5,5	1,1	758.104
50	5,5	1,1	758.105

Ausführung 2
Type 2

HW

B	H	S	Art. Nr.
20	4,1	1,1	758.411
20	5,5	1,1	758.511
25	5,5	1,1	758.512
30	5,5	1,1	758.503
40	5,5	1,1	758.504
50	5,5	1,1	758.505

Ausführung 3
Type 3

HW

B	H	S	Art. Nr.
12	5,5	1,1	758.301
20	5,5	1,1	758.302
30	5,5	1,1	758.303
40	5,5	1,1	758.304
50	5,5	1,1	758.305

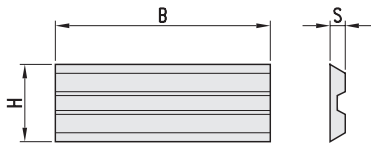
Ausführung mit 2 Schneidkanten
Type with two cutting edges
HW

B	H	S	Maschine	Art. Nr.
56,0	5,5	1,1	Adler	759.101
60,0	5,5	1,1		759.102
71,0	5,5	1,1		759.103
75,5	5,5	1,1	AEG TH75	759.104
			Bosch 0590,P400, 1590, 1591	
			Festo REP 75	
			Haffner FH 222	
			Holz-Her 2223, 2286, 2320	
			Kress Jet Star 6701, EH 6702	
			Mafell HU 75	
			Metabo 6375	
			Scheer MH 80, MH 75/3	
			Skill 98 H	
75,7	5,5	1,1	B & Decker DN 750, BD 750	759.105
			SR 600K	
78,0	5,5	1,1	Virutex (E) HTH75A	759.110
80,5	5,9	1,2	Elu MFF80, MFF 40	759.106
			ADE 80	
82,0	5,5	1,1	AEG EH 82, EH 82S, EH 822	759.107
			EH700, EH450	
			Fein HS 2151	
			Haffner FH 224	
			Hitachi F20, F20A, P20 SA, P 10V	
			F20 20A, FU 20 SA	
			Mafell EHU 82, MHU 82, MHU 82D	
			Makita 1100,1125B, 1900B, 1923B	
			1923 H, 1001, 1901, 1923 HO	
			Metabo Gustav, 4382, HO 0882	
			Bosch GHO40, PHO 150, 100, 200, 300	
82,7	5,5	1,1	B & Decker DN 710, Dn 172, DN 730	759.109
			P71-02, PL 806	

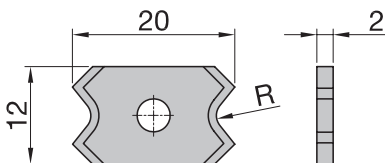

Kantenradiusmesser mit 2 Schneidkanten
Radius cutter with two cutting edges
HW

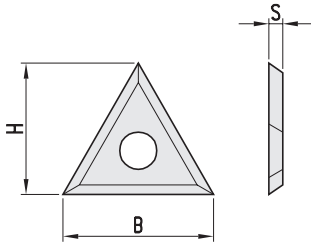
B	H	S	Art. Nr.
12	20	2	798.101
	20	2	798.102
	20	3	798.103
	20	4	798.104
	20	5	798.105

760**HW-Dreieckswendemesser**
*TC Triangle Reversible Knife***PG**
02**Ausführung mit 3 Schneidkanten**
*Type with three cutting edges***HW**

B	H	S	R	Art. Nr.
22	19	2		760.101
	19	2	1	RH 760.201
	19	2	1	LH 760.202

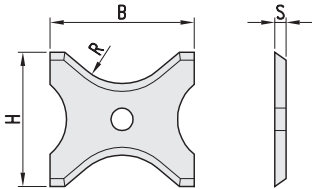
- ▲ Dreieckswendemesser mit gerundeten Kanten (R=1) für Innenkontur
- ▲ triangle reversible knife with rounded edges (R=1) for inner contour

761**HW-Radiuswendemesser**
*TC Radius Reversible Knife***PG**
02**Ausführung mit 2 Schneidkanten**
*Type with two cutting edges***HW**

B	H	S	R	Art. Nr.
13	16	2	2	761.101
	16	2	3	761.102
	16	2	4	761.103
20	21	2	5	761.104
	21	2	6	761.105
	21	2	7	761.106
	21	2	8	761.107
26	24	2	9	761.108
	24	2	10	761.109
	24	2	11	761.110
	24	2	12	761.111
	24	2	13	761.112
30	25	2	14	761.113
	25	2	15	761.114
	25	2	16	761.115

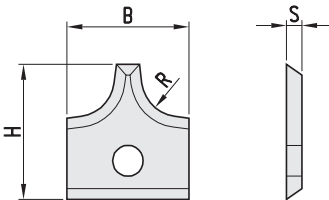
765**HW-Radiuswendemesser**
*TC Radius Reversible Knife***PG**
02**Ausführung mit 2 Schneidkanten**
*Type with two cutting edges***HW**

B	H	S	R	Art. Nr.
16	17,5	2	2	765.101
	17,5	2	3	765.102
	17,5	2	4	765.103
	17,5	2	5	765.104
	17,5	2	6	765.105

766

HW-Räumer – Wendemesser
TC Raker - Reversible Knives

PG
02

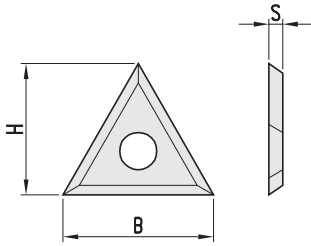

Ausführung mit 4 Schneidkanten
Type with four cutting edges

HW

B	H	S	Art. Nr.
18	18	1,95	766.101
	18	2,45	766.102
	18	2,95	766.103

780

HW-Kantenmesser
TC Chamfering and Rounding Blades

PG
02

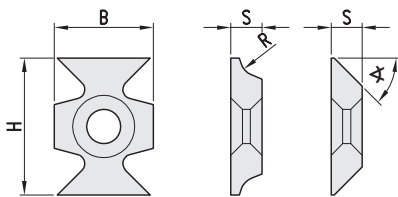

Ausführung mit 2 Schneidkanten
Type with two cutting edges

MEC

HW

B	H	S	R α	Art. Nr.
16	22	5	45°	780.103
	22	5	R1,5	780.205
	22	5	R2	780.207
	22	5	R2,5	780.208
	22	5	R3	780.206
	22	5	4	780.209
	22	5	5	780.210

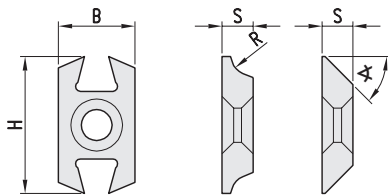

Ausführung mit 2 Schneidkanten
Type with two cutting edges

MAN

HW

B	H	S	R α	Art. Nr.
16	29	5	45°	780.260
	29	5	R2	780.250
	29	5	R3	780.251

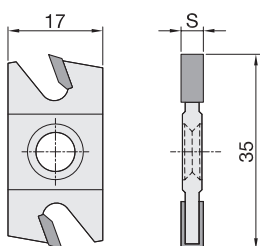
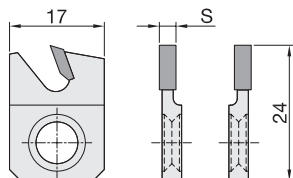
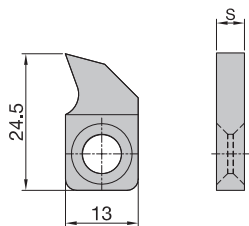

Ausführung mit 1 Schneidkante
Type with one cutting edge
MEC**HW**

B	H	S	Art. Nr.
13	24,5	3	783.100
	24,5	4	783.101
	24,5	5	783.102
	24,5	6	783.103
	24,5	7	783.104

Ausführung MAN mit 1 Schneidkante
Type MAN with one cutting edge
MAN**HW**

B	H	S	Art. Nr.
17	24	3	LH 783.125
	24	3	RH 783.126

Ausführung mit 2 Schneidkanten
Type with two cutting edges
MAN**HW**

B	H	S	Art. Nr.
17	35	4	783.120
	35	5	783.121
	35	6	783.122

771
773

HS/HW-Streifenhobelmesser
HS/TC Strip Planer Blades

PG
02

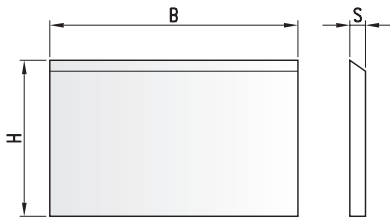

HL/HS

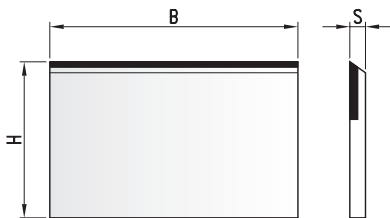

Hartmetallbestückt
TC-tipped

Ausführung mit 1 Schneidkante
Type with one cutting edge

HS

HW

B	H	S	Art. Nr.	Art. Nr.
120	25	3	771.120.25	773.120.25
130		3	771.130.25	773.130.25
150		3	771.150.25	773.150.25
180		3	771.180.25	773.180.25
200		3	771.200.25	773.200.25
250		3	771.250.25	773.250.25
260		3	771.260.25	773.260.25
310		3	771.310.25	773.310.25
350		3	771.350.25	773.350.25
80	30	3	771.080.30	773.080.30
100		3	771.100.30	773.100.30
120		3	771.120.30	773.120.30
130		3	771.130.30	773.130.30
150		3	771.150.30	773.150.30
170		3	771.170.30	773.170.30
180		3	771.180.30	773.180.30
200		3	771.200.30	773.200.30
220		3	771.220.30	773.220.30
230		3	771.230.30	773.230.30
240		3	771.240.30	773.240.30
250		3	771.250.30	773.250.30
260		3	771.260.30	773.260.30
300		3	771.300.30	773.300.30
350		3	771.350.30	773.350.30
400		3	771.400.30	773.400.30
410		3	771.410.30	773.410.30
450		3	771.450.30	773.450.30
500		3	771.500.30	773.500.30
510		3	771.510.30	773.510.30
530		3	771.530.30	773.530.30
600		3	771.600.30	773.600.30
610		3	771.610.30	773.610.30
630		3	771.630.30	773.630.30
640		3	771.640.30	773.640.30
350	35	3	771.350.35	773.350.35
400		3	771.400.35	773.400.35
410		3	771.410.35	773.410.35
450		3	771.450.35	773.450.35
500		3	771.500.35	773.500.35
510		3	771.510.35	773.510.35
530		3	771.530.35	773.530.35
600		3	771.600.35	773.600.35
610		3	771.610.35	773.610.35
630		3	771.630.35	773.630.35

- Weitere Längen auf Anfrage
- *additional lengths are available on request*

Für Elektrohobelmessmaschinen
For electric hand-held planers

HS

HW

B	H	S	Art. Nr.	Art. Nr.
78	25	3,2 Virutex	771.078.25	773.078.25
82	29	3,0 Makita	771.082.29	773.082.29



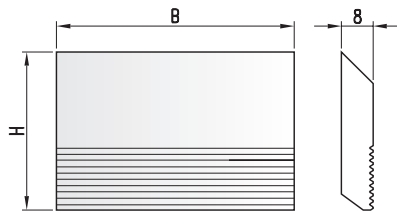

HS

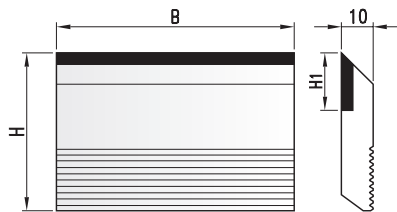

Hartmetallbestückt
TC-tipped

Mit 1 Schneidkante
With one cutting edge

HW

HS

B	H	H1	T	Art. Nr. HW	Art. Nr. HS
4mm-Blanketts					
40	30		4		774.040.30
60					774.060.30
80					774.080.30
100					774.100.30
180					774.180.30
240					774.240.30
650					774.650.30
40	35		4		774.040.35
60					774.060.35
80					774.080.35
100					774.100.35
180					774.180.35
240					774.240.35
650					774.650.35
5mm-Blanketts					
40	27	14	5	787.040.27	774.040.27
60				787.060.27	774.060.27
80				787.080.27	774.080.27
100				787.100.27	774.100.27
180				787.180.27	774.180.27
240				787.240.27	774.240.27
650				787.650.27	774.650.27
40	38	15	5	787.040.38	774.040.38
60				787.060.38	774.060.38
80				787.080.38	774.080.38
100				787.100.38	774.100.38
180				787.180.38	774.180.38
240				787.240.38	774.240.38
650				787.650.38	774.650.38
40	45	17	5	787.040.45	774.040.45
60				787.060.45	774.060.45
80				787.080.45	774.080.45
100				787.100.45	774.100.45
180				787.180.45	774.180.45
240				787.240.45	774.240.45
650				787.650.45	774.650.45
40	50		5		774.040.05
60					774.060.05
80					774.080.05
100					774.100.05
180					774.180.05
240					774.240.05
650					774.650.05

787
774

HW-/HS-Hobelmesser Blanketts – Rückenverzahnt
TC/HSS Back-Serrated Planer Blank Knives

PG
02

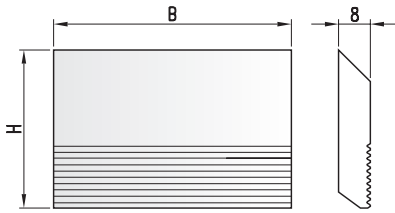

HS

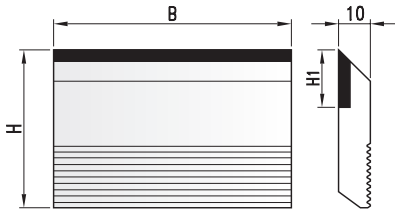

Hartmetallbestückt
TC-tipped

Mit 1 Schneidkante
With one cutting edge

HW

HS

B	H	T	Art. Nr. HS
6mm-Blanketts			
40	40	6	774.040.40
60			774.060.40
80			774.080.40
100			774.100.40
180			774.180.40
240			774.240.40
650			774.650.40
40	50	6	774.040.51
60			774.060.51
80			774.080.51
100			774.100.51
180			774.180.51
240			774.240.51
650			774.650.51
40	60	6	774.040.06
60			774.060.06
80			774.080.06
100			774.100.06
180			774.180.06
240			774.240.06
650			774.650.06
40	70	6	774.040.07
60			774.060.07
80			774.080.07
100			774.100.07
180			774.180.07
240			774.240.07
650			774.640.07

- Weitere Längen auf Anfrage
- *additional lengths available on request*



787
774

HW-/HS-Hobelmesser Blanketts – Rückenverzahnt
TC/HSS Back-Serrated Planer Blank Knives

PG
02

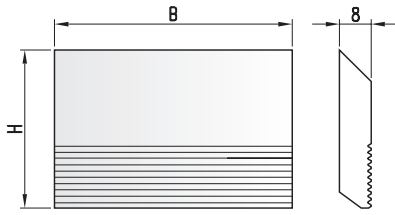

HS

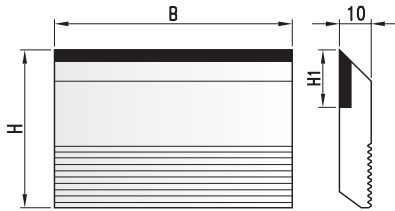

Hartmetallbestückt
TC-tipped

Mit 1 Schneidkante
With one cutting edge

HW

HS

B	H	H1	T	Art. Nr. HW	Art. Nr. HS
8mm-Blanketts					
40	50	15	8	787.040.50	774.040.50
60				787.060.50	774.060.50
80				787.080.50	774.080.50
100				787.100.50	774.100.50
130				787.130.50	774.130.50
150				787.150.50	774.150.50
180				787.180.50	774.180.50
230				787.230.50	774.230.50
635				787.645.50	774.635.50
650					774.650.50
40	60	20	8	787.040.60	774.040.60
60				787.060.60	774.060.60
80				787.080.60	774.080.60
100				787.100.60	774.100.60
130				787.130.60	774.130.60
150				787.150.60	774.150.60
180				787.180.60	774.180.60
230				787.230.60	774.230.60
635				787.635.60	774.635.60
650					774.650.60
40	70	25	8	787.040.70	774.040.70
60				787.060.70	774.060.70
80				787.080.70	774.080.70
100				787.100.70	774.100.70
130				787.130.70	774.130.70
150				787.150.70	774.150.70
180				787.180.70	774.180.70
230				787.230.70	774.230.70
635				787.635.70	774.635.70
650					774.650.70

- Weitere Längen auf Anfrage
- *additional lengths available on request*

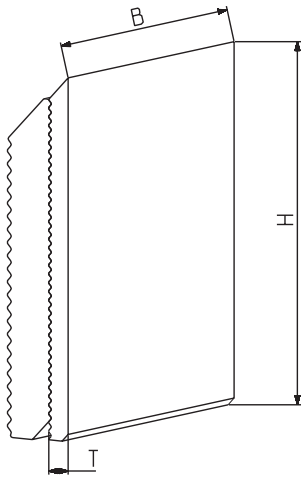
792**HW-Hobelmesser mit Mikroverzahnung – Massiv**
*TC Micro-Serrated Planer Blade - Solid***PG**
02**Mit 1 Schneidkante**
*With one cutting edge***HW**

B	H	T	Art. Nr.
40	38	3,2	792.040.038
60	38	3,2	792.060.038
80	38	3,2	792.080.038
100	38	3,2	792.100.038
150	38	3,2	792.150.038
170	38	3,2	792.170.038
40	50	3,2	792.040.050
50	50	3,2	792.050.050
60	50	3,2	792.060.050
80	50	3,2	792.080.050
100	50	3,2	792.100.050
120	50	3,2	792.120.050
40	60	3,2	792.040.060
50	60	3,2	792.050.060
60	60	3,2	792.060.060
80	60	3,2	792.080.060
100	60	3,2	792.100.060
120	60	3,2	792.120.060
130	60	3,2	792.130.060
150	60	3,2	792.150.060

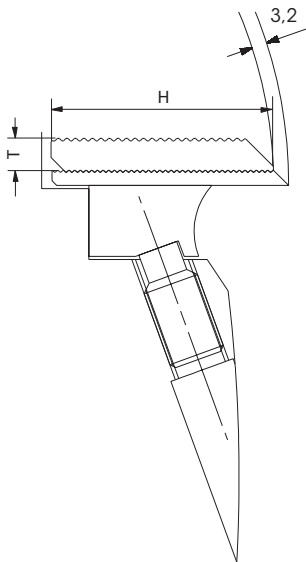
793**WS-Stützplatte mit Mikro- und Rückenverzahnung**
*Tool Steel Support Plate with Micro and Back Serration***PG**
02**Beidseitig verzahnte Stützplatte**
*Double-serrated support plate***HW**

B	H	T	Art. Nr.
40	35	7,1	793.040.035
50	35	7,1	793.050.035
60	35	7,1	793.060.035
100	35	7,1	793.100.035
40	47	7,1	793.040.047
50	47	7,1	793.050.047
60	47	7,1	793.060.047
80	47	7,1	793.080.047
100	47	7,1	793.100.047
130	47	7,1	793.130.047
150	47	7,1	793.150.047
170	47	7,1	793.170.047
40	57	7,1	793.040.057
50	57	7,1	793.050.057
60	57	7,1	793.060.057
70	57	7,1	793.070.057
80	57	7,1	793.080.057
90	57	7,1	793.090.057
100	57	7,1	793.100.057
110	57	7,1	793.110.057
120	57	7,1	793.120.057
130	57	7,1	793.130.057

01



Sägen

02



Hobeln

03



Hobeln / Fräsen

04



Profilfräsen

05



Nub- und Federfräsen

06



Oberfräsen

07



Bohren

08



PKD-Werkzeuge

09



Spannen

10



Ersatzteile

11



Informationen

776
796

HS-/HW-Hobelmesser „CentroLock“ – Wendemesser
HSS/TC Planer Knives “CentroLock” - Reversible Knives

PG
02

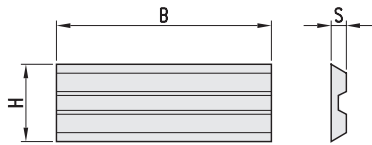

CentroLock-Wendemesser
CentroLock reversible knives

HW

HS

B	H	S	Art. Nr. HS	Art. Nr. HW-
20	16	3	776.020.016	796.020.016
60	16	3	776.060.016	796.060.016
70	16	3	776.070.016	796.070.016
80	16	3	776.080.016	796.080.016
85	16	3	776.085.016	796.085.016
100	16	3	776.100.016	796.100.016
110	16	3	776.110.016	796.110.016
130	16	3	776.130.016	796.130.016
150	16	3	776.150.016	796.150.016
160	16	3	776.160.016	796.160.016
170	16	3	776.170.016	796.170.016
180	16	3	776.180.016	796.180.016
190	16	3	776.190.016	796.190.016
200	16	3	776.200.016	796.200.016
210	16	3	776.210.016	796.210.016
220	16	3	776.220.016	796.220.016
230	16	3	776.230.016	796.230.016
240	16	3	776.240.016	796.240.016
250	16	3	776.250.016	796.250.016
260	16	3	776.260.016	796.260.016
270	16	3	776.270.016	796.270.016
275	16	3	776.275.016	796.275.016
280	16	3	776.280.016	796.280.016
290	16	3	776.290.016	796.290.016
310	16	3	776.310.016	796.310.016
350	16	3	776.350.016	796.350.016
360	16	3	776.360.016	796.360.016
450	16	3	776.450.016	796.450.016
460	16	3	776.460.016	796.460.016

- Weitere Längen auf Anfrage
- *additional lengths available on request*

3458

HS-Messer für Kopiereinheit
HSS Knife for Copying Lathe

PG
02

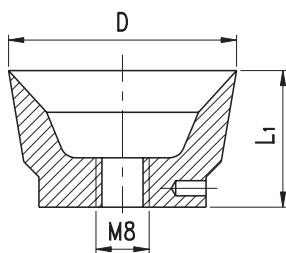

Rundmesser
Rounding knife

HS

D	L1	Art. Nr.
22	15	3458.022.015
30	19	3458.030.019
35	20	3458.035.020
45	26	3458.045.026
50	26	3458.050.026

759
859

HS/HW-Hobelmesser „Tersa“ – Wendemesser
HSS/TC Planer Knives “Tersa” - Reversible Knives

PG
02

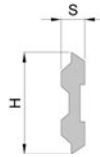
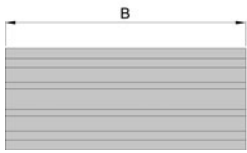

Ausführung mit 2 Schneidkanten
Type with two cutting edges

HS

HW

B	H	S	Art. Nr. HS	Art. Nr. HW-
60	10	2,3	759.060.010	859.060.010
80	10	2,3	759.080.010	859.080.010
100	10	2,3	759.100.010	859.100.010
110	10	2,3	759.110.010	859.110.010
130	10	2,3	759.130.010	859.130.010
150	10	2,3	759.150.010	859.150.010
170	10	2,3	759.170.010	859.170.010
210	10	2,3	759.210.010	859.210.010
230	10	2,3	759.230.010	859.230.010
260	10	2,3	759.260.010	859.260.010
280	10	2,3	759.280.010	859.280.010
310	10	2,3	759.310.010	859.310.010
330	10	2,3	759.330.010	859.330.010
360	10	2,3	759.360.010	859.360.010
410	10	2,3	759.410.010	859.410.010
450	10	2,3	759.450.010	859.450.010
510	10	2,3	759.510.010	859.510.010
610	10	2,3	759.610.010	859.610.010
640	10	2,3	759.640.010	859.640.010
710	10	2,3	759.710.010	
810	10	2,3	759.810.010	
910	10	2,3	759.910.010	

- Nur zur Verwendung in Tersa-Messerköpfen
- Weitere Längen auf Anfrage
- *only suitable for use in Tersa cutterheads*
- *additional lengths available on request*

- 01 Sägen
- 02 Fräsen
- 03 Hobeln / Fräsen
- 04 Profilläsen
- 05 Nut- und Federfräsen
- 06 Oberfräsen
- 07 Bohren
- 08 PKD-Werkzeuge
- 09 Spannen
- 10 Ersatzteile
- 11 Informationen

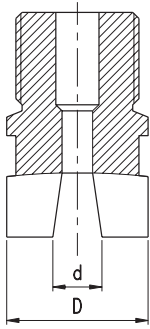
3488**HS-Stabschneider**
HSS Straight Slats CutterPG
02**Stabschneider**
Straight slats cutter**HS**

D	L1	Art. Nr.
25	6,2	3488.025.006
	8,2	3488.025.008
	10,2	3488.025.010
	12,2	3488.025.012

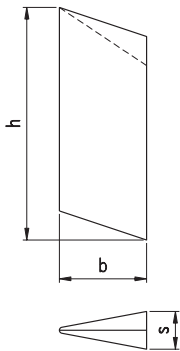
3910**HW-/HS-/ST-Abstechstahl**
TC/HSS/ST Parting-Off Tool for Copying LathePG
02**Abstechstahl**
Parting-off tool**HS**

b	s	h	Schneidstoff - Cutting material	Art. Nr.
25	9,5	100	HS/HS	3910.025.010
	9,5	100	ST/Stellite	3910.025.110
	9,5	100	HW/TC	3910.025.210
40	15,0	110	HS/HS	3910.040.015
	15,0	110	ST/Stellite	3910.040.115
	15,0	110	HW/TC	3910.040.215

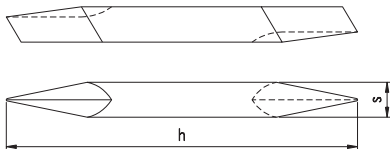
3910**HS-Abstechstahl**
HSS Parting-Off Tool for Copying LathePG
02**Abstechstahl**
Parting-off ool**HS**

D	L1	Art. Nr.
16	150	3910.016.150
20	200	3910.020.200

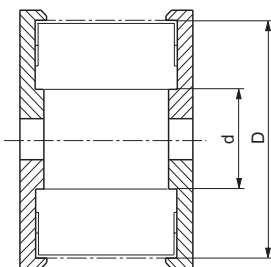
Einstellehre
Setting gauge
HSEinstellehre - *Setting gauge***Art. Nr.**
717.600
Messer-Einstellehre
Setting gauge for blades

D	d	Art. Nr.
125	30	717.201
140		717.202
150		717.203
125	40	717.204
140		717.205
150		717.206
125	50	717.207
140		717.208
150		717.209
163	50	717.210

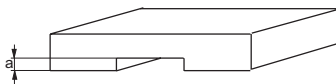
Messer-Einstellehre
Setting gauge for blades

a	Art. Nr.
1	717.302
0,3/0,8	717.309
0,3/1,3	717.310



Gewindestifte und Schrauben
Set screws and screws

DIN 915

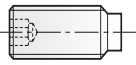

DIN 916

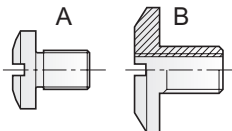
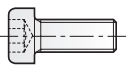
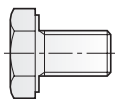
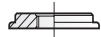
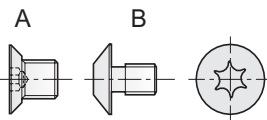
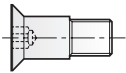

D	Art. Nr.	
Gewindestift mit Innensechskant und Zapfen - DIN 915 set screw with hex socket and tenon		
M5 x 12	705.523	
M5 x 16	705.582	
M6 x 10	705.532	
M6 x 12	705.533	
M6 x 16	705.535	
M8 x 12	705.541	
M8 x 16	705.542	
M8 x 20	705.544	
M8 x 25	705.543	
M10 x 16	705.551	
M10 x 20	705.552	
M10 x 25	705.553	
M12 x 20	705.556	
Gewindestift mit Innensechskant und Kegelspitze - DIN 916 hex socket set screw with conical tip		
M2,5 x 2,5	705.100	
M4 x 4	705.101	
M5 x 5	705.102	
M5 x 8	705.511	
M5 x 10	705.103	
M6 x 6	705.583	
Zylinder-Senkkopf-Schraube mit Innensechskant - Cylinder countersunk screw with hex socket		
M5 x 13,5	705.318	
Torx-Schrauben - Torx screws		
M4 x 3,2	Ausführung - Type A	705.313
M4 x 4,2		705.314
M5 x 7		705.425
M3,5 x 7,5	Ausführung - Type B	705.350
M3,5 x 4		705.352
M4 x 4		705.353
M4 x 6		705.351
M4 x 9		705.354
Torx-Muttern für Wendeschneidmesser - Torx nut for replaceable cutting blades		
M4 x 1,6 (Ø 9,9)		709.128
M4 x 1,7 (Ø 11,9)		709.129
M4 x 2,3 (Ø 11,9)		709.127
Sechskantschrauben mit Gewinde bis zum Kopf - Fully threaded hex head screw		
M10 x 12		705.432
M10 x 17		705.433
Zylinderschraube mit Innensechskant - Hex socket head cap screw		
1/8"		705.501
3/32"		705.502
Spezial-Rundkopfschraube - Special round screw		
M5 x 7/Ø 10	Ausführung - Type A	705.217
M5 x 7/Ø 16		705.214
M6 x 6/Ø 16	Ausführung - Type B	705.218

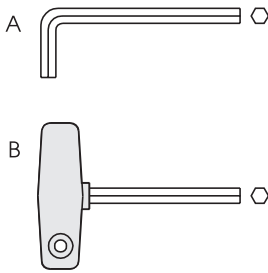
**Sechskantschlüssel**
Hex wrench

HS

Dim.	Art. Nr.
SW 3/32"	706.161
SW 5/64"	706.162
SW 1,3	706.149
SW 1,5	706.150
SW 2	706.151
SW 2,5	706.152
SW 3	706.153
SW 4	706.154
SW 5	706.155
SW 6	706.156
SW 2,5	706.102
SW 3	706.103
SW 4	706.104
SW 5	706.105
SW 6	706.106
SW 10	706.107

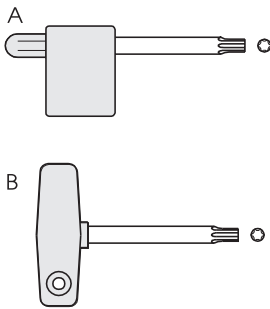
**Torx-Schlüssel**
Torx wrench

Dim.	Art. Nr.
TX9	706.301
TX15	706.302
TX9	706.303
TX15	706.304
TX20	706.305

Drehmomentadapter für 6-kant-Bit (SW 6,35 mm) auf 6-kant-Bit-Schaft (SW 6,35 mm) zur korrekten Vorspannung von Wendepplatten mit Torx-Schrauben

Torque adapter for hex bit (SW 6.35 mm) to hex bit shank (SW 6.35 mm) for correctly pretensioning reversible inserts with torx screws

**Einzelner Drehmomentadapter - Auch zum Betrieb in Handbohrmaschinen geeignet**
Single torque adapter - also suitable for operation in hand drills

M [Nm]	TX	Art. Nr.
2,0 Nm	TX09	923.009.20
3,0 Nm	TX15	923.015.30
5,5 Nm	TX20	923.025.50

Set für 1 Torx-Größe inkl. T-Griff Schlüssel und Torx-Bits in unterschiedlichen Längen
Set for one torx size including T-handle key and torx bits with various lengths

M [Nm]	TX	Art. Nr.
2,0 Nm	TX09	922.009.20
3,0 Nm	TX15	922.015.30
5,5 Nm	TX20	922.020.55

Set für unterschiedliche Torx-Größen inkl. T-Griff Schlüssel und diverse Torx-Bits für gelistete Größen
Set for different torx sizes including T-handle key and various torx bits for listed sizes

M [Nm]	TX	Art. Nr.
Set inkl. diverser Torx-Bits und T-Griff mit diversen Drehmomenten Set including various torx bits and T-handle with various torques		
0,6 Nm	TX6	922.620.55
0,9 Nm	TX7	
1,2 Nm	TX8	
2,0 Nm	TX9	
3,0 Nm	TX15	
5,5 Nm	TX20	



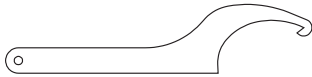

Hakenschlüssel
Hook wrench

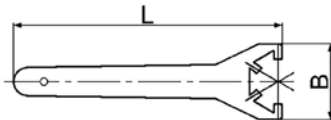
D_{min} - D_{max}	L	Für Spannmuttern	Art. Nr.
30/32	136	426E/ER16	706.505
34/36	170	428E/ER20	706.507
40/42	170	430E/ER25	706.500
45/50	206	470E/ER32	706.504
58/62	240	462E/OZ25	706.503
68/75	240	472E/ER40	706.501
80/90	280	477E/ER50 468E/OZ40	706.502

Schlüssel für Mutter mit 6 Nuten
Spanner for nuts with six grooves

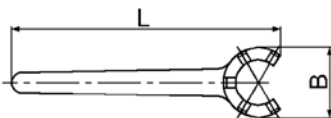
L	B	Für Spannmuttern	Art. Nr.
163	50	ER16	706.016
180	60	ER20	706.701
210	65	ER25	706.711
253	75	ER32	706.709
290	88	ER40	706.715
350	110	ER50	706.71

Schlüssel für Minimuttern
Spanner for mini nuts

L	B	Für Spannmuttern	Art. Nr.
117	22,5	ER16	706.716
128	28	ER20	706.714
145	36	ER25	706.712

835**Montageständer für HSK85WS-Werkzeuge***Workstand for HSK85WS tools***PG
02****HSK85WS-Montageständer**
*HSK85WS workstand***HS****Bezeichnung**

HSK85WS-Messspindel

Art. Nr.**835.250.015****01****02****03****04****05****06****07****08****09****10****11****719****Messtisch mit Stativ und mechanischer Messuhr***Table of Geometric Control***PG
02****Messtisch mit Messuhr**
*Table of geometric control***HS****Bezeichnung**

Messtisch

Art. Nr.**719.101****723****Prüf- und Einstellhilfe für Schneidenflugkreis von Hobelmessern***Test and Adjustment Tool for Cutting Circle of Planer Blades***PG
02****Prüf- und Einstellhilfe**
*Control device***HS****Bezeichnung**

Prüf- und Einstellhilfe

Art. Nr.**723.101**

- Digitale Prüf- und Einstelllehre für den Schneidenflugkreis von Hobelmessern oder für die Rundlaufmessung an Oberfräsen.
- Schenkel der Einstelllehre auf Maschinentisch Hobelmaschine aufsetzen. Den Rundlauf der einzelnen Hobelmesser zueinander auf Hobelwelle so ermitteln.
- Auch zur Vermessung/Einstellung von Frästiefen, Bohrtiefen und Hobeltiefen geeignet.
- Digital inspection and adjustment gauge for the cutting circle of planer blades or for measuring concentricity on router tables.
- Place the legs of the adjustment gauge on the planer table. Use it to determine the concentricity of the individual planer blades relative to each other on the planer shaft.
- Also suitable for measuring/adjusting milling depths, drilling depths, and planing depths.

4000
4400

Entharzer – Sprühflasche Resin Remover in Spray Bottle

PG
02



Universal-Reinigungsmittel All-purpose cleaning product

Bezeichnung	Verpackungseinheit	Art. Nr.
1 Liter Sprühflasche Entharzer für Alu-Werkzeuge	6	4400.0100
1 Liter Entharzer für Stahlwerkzeuge	1	4000.0100

Schnellentharzer zur universellen Anwendung. Entfernt zuverlässig normale und hartnäckige sowie organische und anorganische Verschmutzungen von sämtlichen Werkzeugen. Überzeugt durch seine umwelt- und anwenderfreundliche Zusammensetzung:

- Frei von gesundheitsschädlichen Inhaltsstoffen
- Biologisch abbaubar
- Reinigt schnell und rückstandsfrei

Achtung: Regelmäßiges Entharzen der Werkzeuge lohnt sich. Verharzte Werkzeuge verkürzen die Standzeiten erheblich, verschlechtern die Schnittgüte und erhöhen den Stromverbrauch.

Quick resin remover for multi-purpose use. Reliably removes regular and stubborn as well as organic and anorganic debris from all tools. The cleaning product stands out due to its environmentally friendly and user-friendly composition:

- free from harmful ingredients
- biodegradable
- cleans quickly without leaving residue

Caution: Regularly removing resin from tools is worthwhile, as resin-clogged tools significantly shorten tool life, degrade cut quality, and increase power consumption.

4000
4400

Entharzer für Werkzeuge aus Stahl und Aluminium Resin Remover for Steel and Aluminium Tools

PG
02



AX-Entharzer für Aluminiumwerkzeuge AX cleaner for aluminium tools

Bezeichnung	Verpackungseinheit	Art. Nr.
5-Liter-Kanister, Konzentrat - 5-litre canister, concentrate	5 l	4400.0500

Anwendung: Dieser Schnellentharzer ist speziell für Aluminiumwerkzeuge geeignet und wird im Verhältnis 1:10 mit 50 Liter Wasser verdünnt.

Usage: This quick resin remover is specifically designed for aluminium tools and should be diluted at a ratio of 1:10 with 50 litres of water.

SX-Reiniger für Stahlwerkzeuge SX cleaner for steel tools

Bezeichnung	Verpackungseinheit	Art. Nr.
5-Liter-Kanister, Konzentrat - 5-litre canister, concentrate	5 l	4000.0500

Anwendung: Dieser Schnellentharzer ist speziell für Stahlwerkzeuge geeignet und wird im Verhältnis 1:5 mit 25 Liter Wasser verdünnt.

Achtung: Werkzeuge aus Aluminium dürfen mit diesem Produkt nicht in Berührung kommen.

Usage: This quick resin remover is specifically designed for steel tools and should be diluted at a ratio of 1:5 with 25 litres of water.

Caution: Aluminium tools must not come into contact with this product.

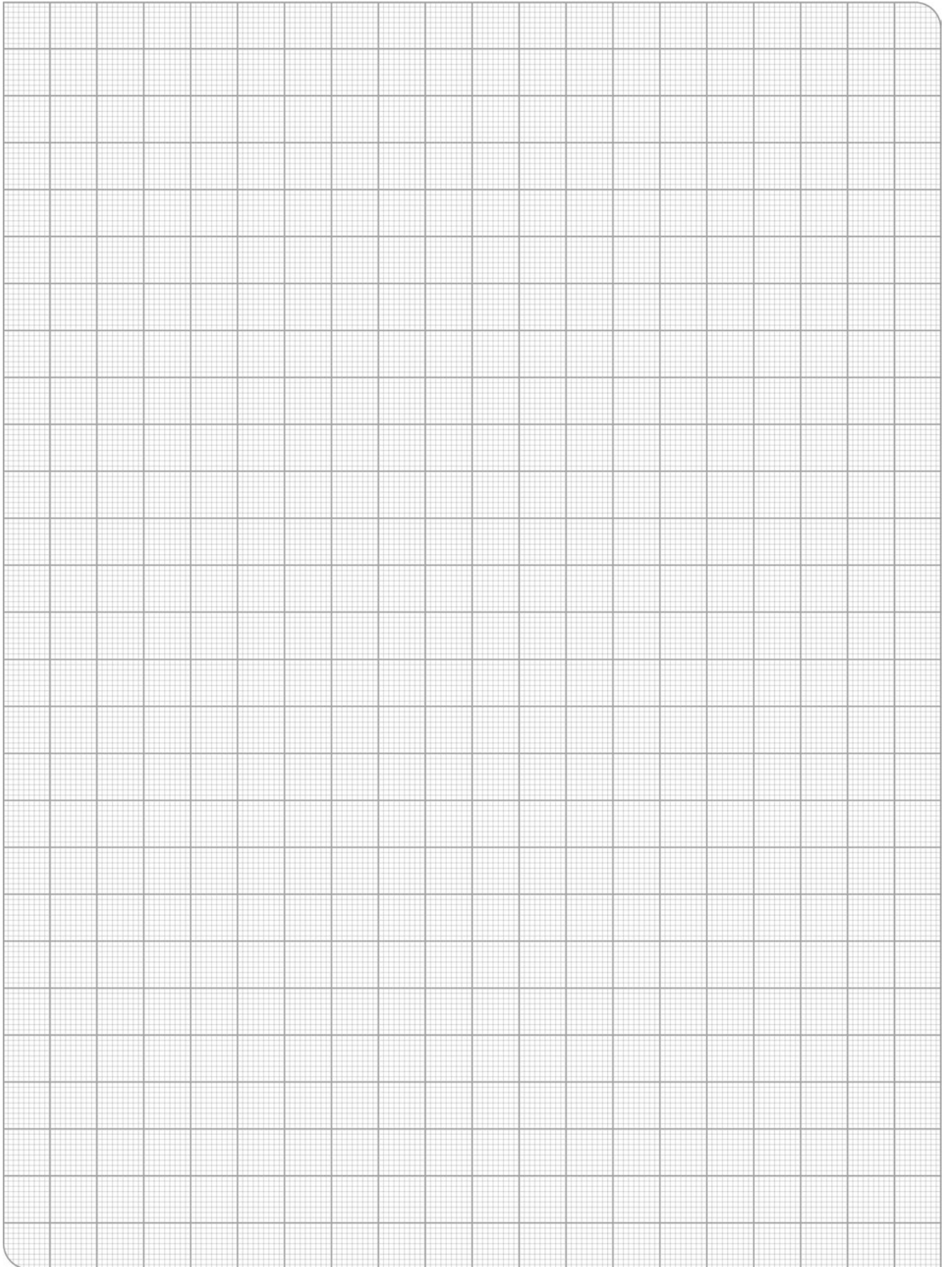

- 01  Säge
- 02  Zerspanen
- 03  Hobeln / Fräsen
- 04  Profilfräsen
- 05  Nul- und Federfräsen
- 06  Oberfräsen
- 07  Bohren
- 08  PKD-Werkzeuge
- 09  Spannen
- 10  Ersatzteile
- 11  Informationen

